

CT87A,B,J Round[®] Thermostat

LOW VOLTAGE (15 TO 30 VAC),
THERMOSTAT AND MOUNTING HARDWARE

Installation Instructions

1 Verify that you have the correct thermostat

Using the compatibility chart below, verify that you purchased the correct CT87Thermostat for your heating/cooling system. If you are unsure which model is right for your system, visit www.honeywell.com/yourhome or call Honeywell Customer Care at 1-800-468-1502.



Heating/Cooling system	Compatible with:		
	CT87A	CT87B	CT87J
Heating only: Gas or oil fueled warm air, steam, or hot water heat	Yes	Yes	No
Cooling only: Electric air conditioning	Yes*	Yes	Yes
Heating and cooling: Gas or oil fueled warm air, steam, or hot water heat with electric air conditioning	No	Yes	No
Single stage heat pump: Outdoor heating/cooling unit (compressor) with no auxiliary or backup heat.	No	No	Yes
Electric heat furnace with or without cooling:	No	No	Yes
Electric baseboard: Electric heating strips located just above the floor, usually 120-240 volts	No	No	No
Multistage: A conventional system with more than one stage, or an outdoor heating/cooling unit (compressor) with auxiliary or backup heat.	No	No	No

* CT87A is compatible with 2-wire cooling-only systems.



2 Prepare for installation

- Carefully unpack your new thermostat; rough handling may affect its accuracy. Save your receipt and identify the following parts:
 - CT87 Thermostat
 - Screws: two 1-in. sheet metal screws, two 1/2-in. binding head screws, and two 1/4-in. round head screws
 - Wallplate (CT87A) or subbase (CT87B, CT87J)
 - Cover ring (select models only). Necessary if installing on an outlet box. Optional if installing directly on the wall; can be used to hide wall marks.
 - These Installation Instructions and the Installation Quick Guide.
 - Wiring labels
- Gather these tools:

Required Tools	Optional Tools
<ul style="list-style-type: none"> • Flat blade screwdriver • Spirit level 	<ul style="list-style-type: none"> • Hand or power drill with 1/16-in. drill bit • Wire cutter/stripper or sharp knife • Pencil

3 Remove the old thermostat

- Turn off power** to the heating/cooling system at the main fuse/circuit breaker panel.
- Remove the cover of your old thermostat. You may need to unscrew the cover if it is locked on.
- Locate the heat anticipator adjustment scale and lever on the old thermostat (Fig. 1).

Fig. 1. Mercury switch location.

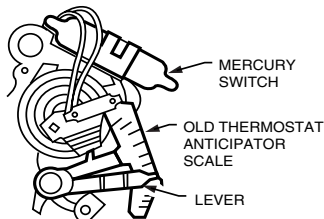

TYPICAL LOCATION OF A MERCURY SWITCH IN A THERMOSTAT

M20206

In the box below, record the number that the adjustment lever points to. This is the current (amp) rating of your heating system.

Current setting:

If you cannot find the heat anticipator setting on the old thermostat, you can use a standard setting for your type of system when you reach Step 8 of this installation.

- Unscrew and remove the old thermostat wallplate from the wall, but **do not disconnect the wires.**

5. Label the wires using the wiring labels that came with the CT87. Identify each wire using the letter of the terminal on the **old thermostat** (Fig. 2). Do not label the wires by color.
6. Disconnect the wires from the old thermostat and wrap them around a pencil to keep them from falling back into the wall (Fig. 3).

Fig. 2. Labeling wires.

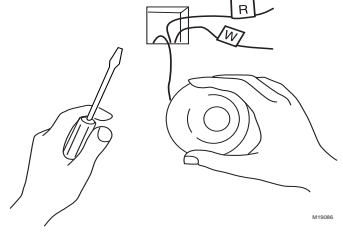
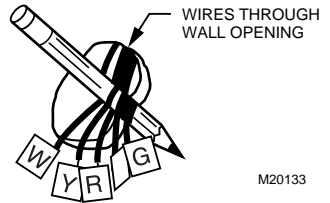

Fig. 3. Wrapping wires.



MERCURY NOTICE

If this thermostat is replacing a control that contains mercury in a sealed tube, do not place your old control in the trash. Contact your local waste management authority for instructions regarding recycling and the proper disposal of this control, or of an old control containing mercury in a sealed tube.

4 Install the cover ring and wallplate or subbase

If installing on the wall

Refer to Fig. 4 as you work.

Fig. 4. Installing wallplate/subbase on the wall (wallplate shown).

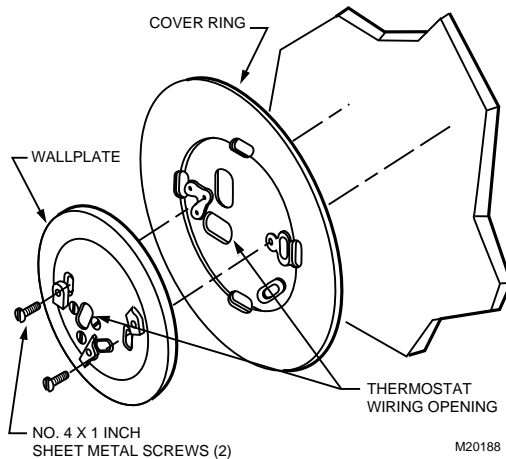

1. **If using the cover ring:** Position the cover ring against the wall so that the arrow in the middle of the cover ring is pointing up.
2. Position the wallplate or subbase.
 - **If using cover ring:** Place the wallplate/subbase over the cover ring. Rotate the wallplate/subbase until the wiring openings are aligned and the two screw holes on the left and right side of the wallplate/subbase align with the screw holes on the cover ring. You will be inserting screws through these holes into the wall.
 - **If attaching wallplate directly to the wall:** Position so that the UP indicator on the wallplate is on top.
 - **If attaching subbase directly to the wall:** Position so that the fan and heating/cooling switches are on the top.
3. Use a pencil to mark the center of the screw holes on the left and right sides of the wallplate or subbase.
4. Remove the wallplate/subbase and cover ring, and drill two 1/16-in. holes at the locations you marked.
5. Reposition the cover ring (if used) and wallplate/subbase over the holes, pull the wires through the wiring opening, and loosely insert the two 1-in. screws into the drilled holes.

If installing on an outlet box

Refer to Fig. 5 as you work.

Fig. 5. Installing wallplate/subbase on an outlet box (subbase shown).

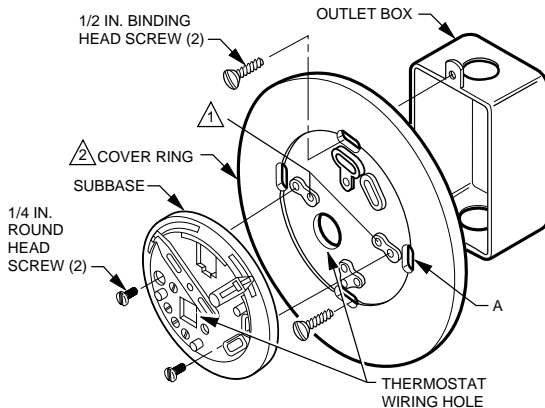

- ⚠ THE TWO INNER HOLES ARE USED WITH WALLPLATE.
- ⚠ IF OUTLET BOX IS HORIZONTAL, MOUNT COVER RING IN POSITION SHOWN, BUT FASTEN WITH SCREWS THROUGH "A".

M20187

1. Place the cover ring against the outlet box so that the arrow in the middle of the cover ring is pointing up.
2. Pull the wires through the wiring hole on the bottom left side of the cover ring.
3. Align the screw slots on the cover ring with the outlet box screw holes, and attach the cover ring to the outlet box with two 1/2-in. screws.
4. Place the wallplate or subbase over the cover ring so that the wiring holes line up, and pull the wires through.
5. Loosely attach the wallplate/subbase to the cover ring with two 1/4-in. screws, through the screw holes on the left and right sides of the wallplate/subbase.

5 Level the wallplate or subbase

IMPORTANT: The wallplate/subbase must be level to maintain accurate thermostat temperature.

1. Rotate the wallplate/subbase until level as shown in Fig. 6. To level the subbase, use the leveling posts directly below the Heat and Fan indicators.

Fig. 6. Leveling the wallplate.

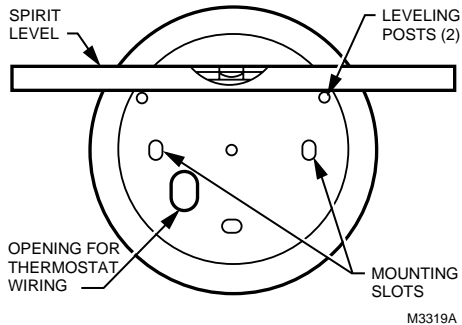

2. Tighten the mounting screws after making sure that the wallplate or subbase is level.

6 Wire the thermostat

1. Use the wiring cross-reference table below to match each old thermostat wire with its corresponding terminal on the CT87 wallplate or subbase. See Fig. 8 through 13 wiring diagrams.

Wiring Cross-reference			
Wire Label	Connect to CT87A	Connect to CT87B	Connect to CT87J
R, RH, 4, V	R	RH	R
Rc, R		Rc	
W, W ₁ , H	W	W	W
Y, Y ₁ , M	Y	Y	Y
G, F		G	G
B	See Fig. 9		B*
O			O*
See Fig. 13			P

*Never attach wires to both the B and O terminals.

2. Strip the wire insulation as needed to fit the wires underneath the terminal screws (Fig. 7).

Fig. 7. Fitting wires under the terminal screws.

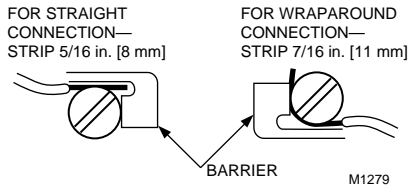

3. Loosen the terminal screws and slip each wire beneath its matching terminal.
4. Securely tighten the terminal screws.
5. Push any excess wire back into the wall.

Fig. 8. CT87A for a 2-wire heating only system.

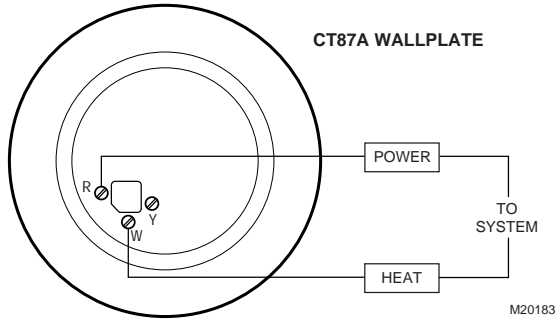

Fig. 9. CT87A for a 3-wire hot water heating only system.

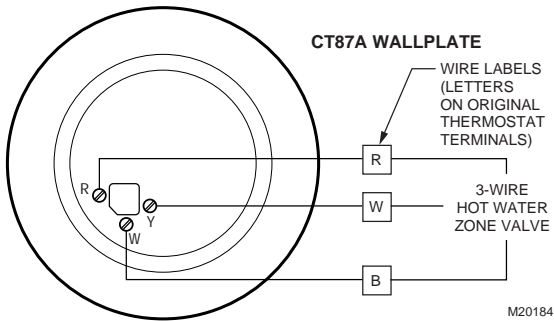

Fig. 10. CT87B for a 4-wire heating/cooling system.

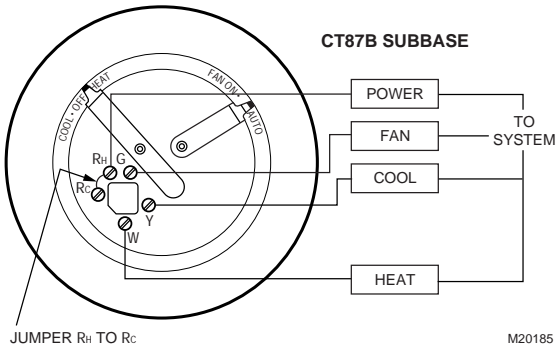
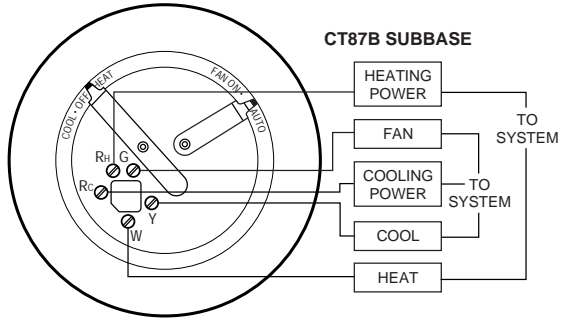
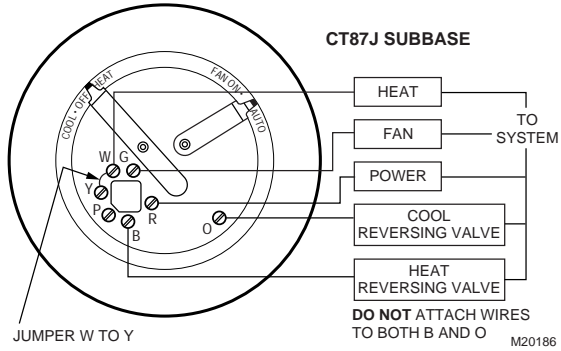

Fig. 11. CT87B for a 5-wire heating/cooling system.



M20225

Fig. 12. CT87J for a 4-wire single stage heat pump.



M20186

Fig. 13. CT87J for 4-wire single stage heat pump.

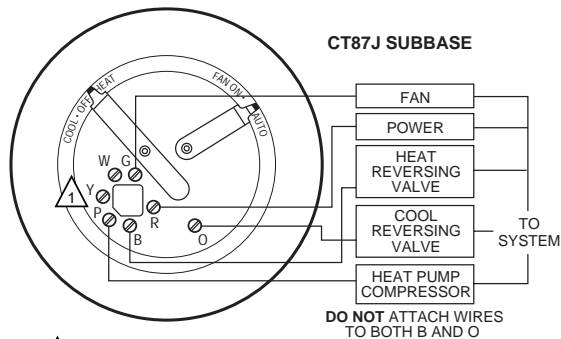

⚠ IF WIRES ARE ATTACHED TO Y OR W, AND P ON YOUR OLD THERMOSTAT, CONTACT YOUR LOCAL CONTRACTOR FOR FURTHER ASSISTANCE.

M20228

7

Mount the thermostat

1. Pull off the thermostat cover and discard the red plastic insert that holds the mercury switch in place during shipping.
2. Using a pencil point, slide the heat anticipator indicator to 1.2 on the scale as shown in Fig. 14.

IMPORTANT: This prevents the thermostat from being damaged.

Fig. 14. Adjusting heat anticipator indicator.

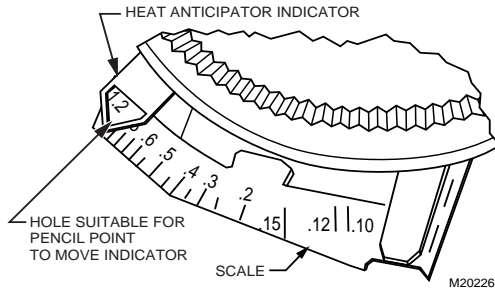

3. Place the thermostat over the wallplate or subbase so that the three captive mounting screws align with the three raised screw holes on the wallplate/subbase.
4. Tighten the three captive mounting screws as shown in Fig. 15.

NOTE: These screws complete the installation of the thermostat.

Fig. 15. Tightening mounting screws.

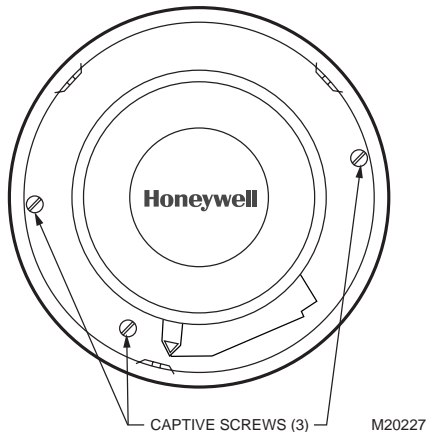

8 Set the heat anticipator for your system

IMPORTANT: Setting the heat anticipator allows the thermostat to maintain accurate temperature control.

- Using a pencil point, move the heat anticipator pointer to the number that you recorded in Step 3, sub-step 3. If you could not find the anticipator setting on the old thermostat, use the setting for your type of system shown in the table below.

Your heating system:	Heat anticipator setting:
Steam	1.2
Hot water heat	0.8
High-efficiency warm air	0.8
Standard warm air	0.4
Electric heat	0.3

- Snap on the thermostat cover.

NOTE: If the furnace stays on beyond the thermostat set temperature, move the anticipator pointer down by .1 ampere. If the furnace shuts off before the set temperature is reached, move the anticipator pointer up by .1 ampere. Never adjust the anticipator below .3 ampere.

9 Check heating/cooling operation

Check heating

- Turn the transparent dial to the farthest point left.
- If your CT87 has a subbase, set the system switch to Heat.
- Turn the dial until the temperature on the setting scale (Fig. 16) exceeds the room temperature that is shown on the thermometer. The heating system should start.
- Turn the dial until the temperature on the setting scale is below the room temperature that is shown on the thermometer. The heating system should stop.

Fig. 16. Checking heating system.

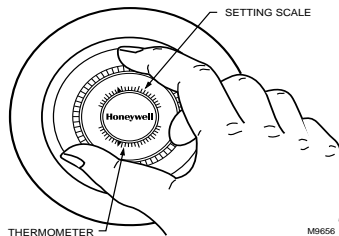

Check cooling

IMPORTANT: To avoid damaging the compressor in the air conditioner, do not operate the cooling system when the outdoor temperature is below 50°F (10°C).

1. If your CT87 has a subbase, set the System switch on the left to Cool.

IMPORTANT: After heating is tested, wait five minutes before switching to Cool on the CT87J model.

2. Lower the temperature setting below room temperature. The cooling system should start.
3. Raise the temperature setting above room temperature. The cooling system should stop.

Operation

To set the temperature, turn the dial until the pointer on the top setting scale aligns with the desired temperature.

CT87B, J switches

Switch	Setting	Result
System	Cool	The thermostat controls your cooling system.
	Off	Both the heating and cooling systems are off.
	Heat	The thermostat controls your heating system.
Fan	On	The fan runs continuously.
	Auto	The fan runs only with the heating or cooling system.

Limited One-Year Warranty

Honeywell warrants this product, excluding battery, to be free from defects in the workmanship or materials, under normal use and service, for a period of one (1) year from the date of purchase by the consumer. If, at any time during the warranty period, the product is defective or malfunctions, Honeywell shall repair or replace it (at Honeywell's option) within a reasonable period of time.

If the product is defective,

- (i) return it, with a bill of sale or other dated proof of purchase, to the retailer where you purchased it, or
- (ii) package it carefully, along with proof of purchase (including date of purchase) and a short description of the malfunction, and mail it, postage prepaid, to the following address:

Honeywell Inc. USA
Dock 4 — MN10-3860
1985 Douglas Drive North
Golden Valley, MN 55422-3992

Honeywell Canada:
Honeywell Limited/Honeywell Limitée
35 Dynamic Drive
Scarborough, Ontario M1V 4Z9

This warranty does not cover removal or reinstallation costs. This warranty shall not apply if it is shown by Honeywell that the defect or malfunction was caused by damage which occurred while the product was in the possession of a consumer.

Honeywell's sole responsibility shall be to repair or replace the product within the terms stated above. HONEYWELL SHALL NOT BE LIABLE FOR ANY LOSS OR DAMAGE OF ANY KIND, INCLUDING ANY INCIDENTAL OR CONSEQUENTIAL DAMAGES RESULTING, DIRECTLY OR INDIRECTLY, FROM ANY BREACH OF ANY WARRANTY, EXPRESS OR IMPLIED, OR ANY OTHER FAILURE OF THIS PRODUCT. Some states do not allow the exclusion or limitation of incidental or consequential damages, so this limitation may not apply to you.

THIS WARRANTY IS THE ONLY EXPRESS WARRANTY HONEYWELL MAKES ON THIS PRODUCT. THE DURATION OF ANY IMPLIED WARRANTIES, INCLUDING THE WARRANTIES OF MERCHANTABILITY AND FITNESS FOR A PARTICULAR PURPOSE, IS HEREBY LIMITED TO THE ONE YEAR DURATION OF THIS WARRANTY. Some states do not allow limitations on how long an implied warranty lasts, so the above limitation may not apply to you.

This warranty gives you specific legal rights, and you may have other rights which vary from state to state.

If you have any questions concerning this warranty, please write Honeywell Customer Care, Honeywell Inc., 1985 Douglas Dr. N., Golden Valley, MN 55422-3992, or call 1-800-468-1502. In Canada, write Retail Products ON15, Honeywell Limited/Honeywell Limitée, 35 Dynamic Drive, Scarborough, Ontario M1V 4Z9.



Automation and Control Solutions

Honeywell
1985 Douglas Drive North
Golden Valley, MN 55422

Honeywell Limited-Honeywell Limitée
35 Dynamic Drive
Scarborough, Ontario
M1V 4Z9

